

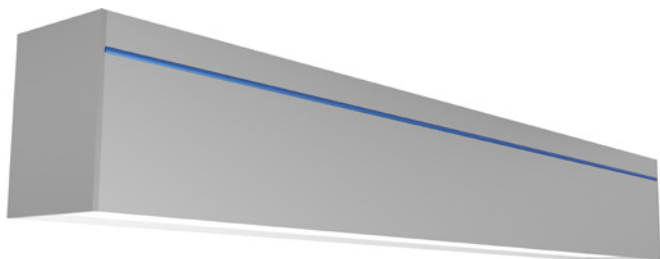

GLENDAR 40W

ARCHITECTURAL LIGHT SPECIFICATION SHEET



▼ CERTS

RoHS

CE

CB



▼ DIMENSIONS

4' MODULE

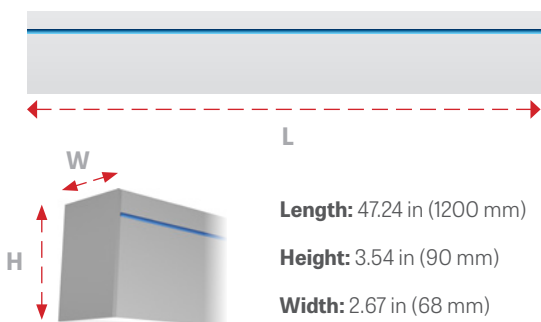

▼ PHOTOMETRICS

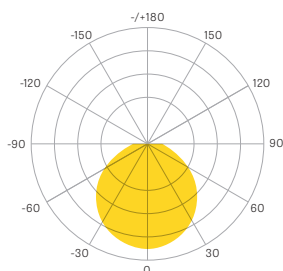

120°
Frosted Cover

▶ OPTICAL SPECS

Max System Efficacy	125 Lm/W
Max Output	4,747 Lumens
CCT	30K / 35K / 40K / 45K
CRI	> 80 Ra
Beam Angle	120°

▶ ELECTRICAL SPECS

Input Voltage	AC 100 - 277 Volts
Power Frequency	50 / 60 Hz
Power Factor	> 0.93
Efficiency	> 92%
Dimming Function	0 - 10V
Total Harmonic Distortion	< 17%

▶ OTHER DETAILS

System Power Usage	40W
Ingress Protection	IP20
Luminaire Net Weight	8.122 lbs (3.684 kg)
Lifespan	≥ 50,000 Hours
Storage Temperature	-40° ~ 185°F (-40° ~ 85°C)
Operating Temperature	-20° ~ 104°F (-20° ~ 40°C)
Product Dimensions	47.24 x 3.54 x 2.67 in (1200 x 90 x 68 mm)
AC Input Cable Length	2ft 7.5in (800mm)

▶ CONTROLS & ACCESSORIES

Options	Dimming / Linking
Mounting	Fixed surface std. (incl.) / Multi-Angle / Surface / Suspension
Suspension Cable Length	3ft 11in (1.2m) standard
Color Options	Silver RAL 7074 (standard) White RAL 9016 (MOQ 200) Black RAL 9017 (MOQ 500)
Accent Color Options	Blue RAL 5017 (standard) Red RAL 3020 (optional)

After choosing options to create the perfect controlled fixture for your space, this chart will help you create the correct SKU necessary to order.

ARCHITECTURAL LIGHT

PRODUCT	WATTAGE	A CCT	B COVER	C FIXTURE LENGTH	D OPTIONS
GEDAR	15W	30K / 35K / 40K / 45K	FC	2	(N/A) / D / L / LD
GEDAR	20W	30K / 35K / 40K / 45K	FC	3	(N/A) / D / L / LD
GEDAR	30W	30K / 35K / 40K / 45K	FC	4	(N/A) / D / L / LD
GEDAR	40W	30K / 35K / 40K / 45K	FC	4	(N/A) / D / L / LD

Create your SKU:

GEDAR					
PRODUCT	WATTAGE	CCT	COVER	LENGTH (FIXED)	OPTIONS
Accessory SKUs if applicable (separate by comma)					Fixture Quantity

SKU CREATOR GUIDELINES

- Options in chart separated by slash (/)
- Choose one option per column.
- All characters must **always** utilize capitalization. No special characters (/ , & , #, etc.) will be permitted.
- White space in between columns indicates single space in SKU.

SKU CREATOR CATEGORY KEY

To select standard fixture - leave **OPTIONS** column blank.

A CCT - COLOR TEMP.	B COVER	C FIXTURE LENGTH	D OPTIONS
30K - 3,000 Kelvin 35K - 3,500 Kelvin 40K - 4,000 Kelvin 45K - 4,500 Kelvin	FC - Frosted Cover	2 - 2 feet 3 - 3 feet 4 - 4 feet	(N/A) - Standard Body D - Dimmable L - Linkable LD - Linkable & Dimmable

ACCESSORY SKUS

Order accessories as separate part number from your Fixture SKU. Learn more about these options on the Accessories Page.

SKU	DESCRIPTION
GEDARA Cable Mount	Architectural LED Linear Fixture 1.2 Meter Cable Mount-Set of Two
GEDARA Adj. Mount	Architectural LED Linear Fixture Adjustable Surface Mount-Set of Two
GEDARA L Bracket	Architectural LED Linear Fixture L-Connector Bracket
GEDARA EXT 1.5	Architectural LED Linear Fixture 1.5M Cord Extension
GEDARA FC Black	Architectural LED Linear Fixture Body Color Black RAL 9017 (MOQ>500pcs)
GEDARA FC White	Architectural LED Linear Fixture Body Color White RAL 9016 (MOQ>200pcs)
GEDARA TRIM Red	Architectural LED Linear Fixture Accent Color Red RAL 3020

FIXTURE OPTIONS

Necessary choices to configure product



ACCESSORY OPTIONS

▶ SUSPENSION CABLE

SKU	PHOTO
GLEDARA Cable Mount	
Suspend the GLEDARA unit from the ceiling for an accented look and feel.	

▶ ADJUSTABLE CEILING MOUNT

SKU	PHOTO
GLEDARA Adj. Mount	
Ability to mount fixtures to the surface and have multiple lighting angles with the multi-angle bracket.	

▶ L BRACKET

SKU	PHOTO
GLEDARA L BRACKET	
Attach units at a 90 degree angle.	

▶ BLACK BODY

SKU	PHOTO
GLEDARA FC BLACK	
Go for a sleek, dark body to either suit a darker ceiling or accent against a lighter one.	

▶ WHITE BODY

SKU	PHOTO
GLEDARA FC WHITE	
Get a classic look with white body unit. Blend it in with a light ceiling or have it stand out against a darker one.	

▶ ACCENT COLORS

SKU	PHOTO
GLEDARA TRIM Red	
Stay with the standard blue stripe or choose the optional red to match your decor.	

CONFIGURATION OPTIONS

THE CORRECT CONNECTIONS FOR YOUR DESIGN



GLEDAR Configuration Options

In order to create different configuration designs, you must make sure to purchase light banks with the correct link connection ends.

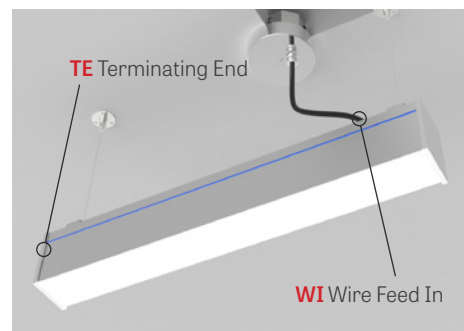
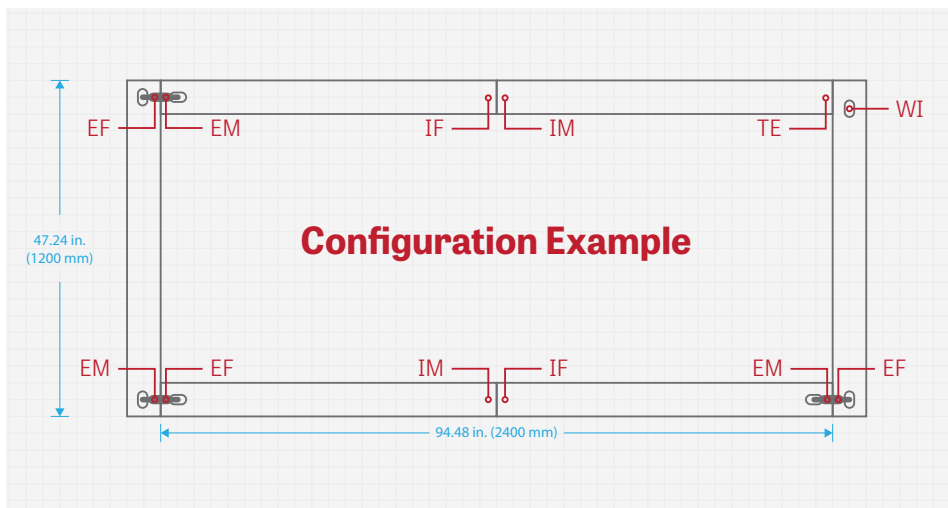
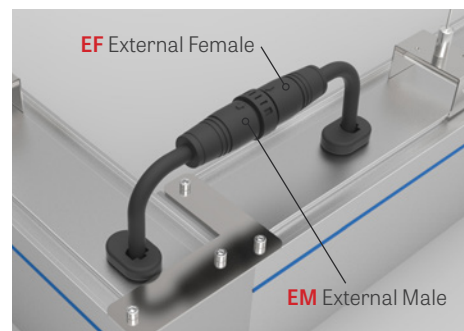
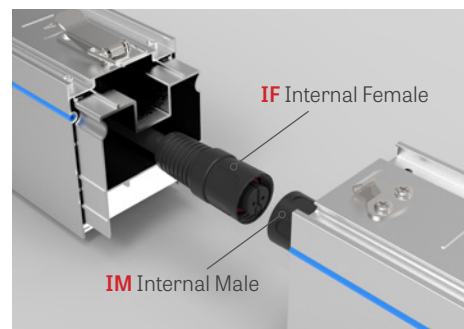

ACCESSORY SKUS

SKU	DESCRIPTION
GLEDARA Linking WI/EF	Architectural LED Linking Configuration - Wire In/External Female
GLEDARA Linking WI/IF	Architectural LED Linking Configuration - Wire In/Internal Female
GLEDARA Linking EM/EF	Architectural LED Linking Configuration - External Male/External Female
GLEDARA Linking EM/IF	Architectural LED Linking Configuration - External Male/Internal Female
GLEDARA Linking IM/EF	Architectural LED Linking Configuration - Internal Male/External Female
GLEDARA Linking IM/IF	Architectural LED Linking Configuration - Internal Male/Internal Female
GLEDARA Linking EM/TE	Architectural LED Linking Configuration - External Male/Terminating End Cap
GLEDARA Linking IM/TE	Architectural LED Linking Configuration - Internal Male/Terminating End Cap